



*Digi Connect SP™ and
Digi Connect Wi-SP™
Hardware Reference*

Making
DEVICE NETWORKING
easy™

© Digi International Inc. 2003, 2004, 2005. All Rights Reserved.

The Digi logo is a registered trademark of Digi International, Inc.

Digi Connect SP and Digi Connect Wi-SP are trademarks of Digi International, Inc.

NetSilicon, NET+Works, NET+OS, and NET+ are trademarks of NetSilicon, Inc.

All other trademarks mentioned in this document are the property of their respective owners.

Information in this document is subject to change without notice and does not represent a commitment on the part of Digi International.

Digi provides this document "as is," without warranty of any kind, either expressed or implied, including, but not limited to, the implied warranties of fitness or merchantability for a particular purpose. Digi may make improvements and/or changes in this manual or in the product(s) and/or the program(s) described in this manual at any time.

This product could include technical inaccuracies or typographical errors. Changes are periodically made to the information herein; these changes may be incorporated in new editions of the publication.

Contents

About This Guide	7
Purpose	7
Related Documentation	7
Chapter 1: Introducing the Digi Connect SP & Digi Connect Wi-SP Hardware	9
Hardware Overview	9
LEDs.....	11
Reset Button	12
Antenna	13
MEI 232/422/485 Switch Settings	13
DB-9 Connector	14
JTAG Interface	15
Power Jack.....	16
Chapter 2: Programming Considerations.....	19
GPIO.....	19
GPIO Pin Use	21
LEDs.....	21
Flash	22
Memory	22
Reset Button	23
Appendix A: Specifications.....	25
Network Interfaces	25
Serial Interface	26
Data Rates (bps)	26
Flow Control Options.....	26

Environmental 26

Power Requirements 27

Mechanical 27

Antenna Information 28

RF Exposure Statement..... 32

Overlay Specifications 33

Appendix B: Certifications 35

 FCC Part 15 Class A 35

 Industry Canada 36

 International EMC Standards..... 37

Appendix C: Change Log 39

 Revision D..... 39

 Revision C..... 39



About This Guide

Purpose

The purpose of this guide is to assist developers creating custom embedded software for the Digi Connect SP and Digi Connect Wi-SP platform using the NET+OS operating system and tools.

Related Documentation

See the *NS7520 Hardware Reference* for information on the NS7520 chip.

See the *NET+Works BSP Porting Guide* for additional programming information.

Introducing the Digi Connect SP & Digi Connect Wi-SP Hardware

C H A P T E R 5

Hardware Overview

The following figure identifies various Digi Connect SP and Digi Connect Wi-SP connectors, LEDs and switches.

Digi Connect SP Hardware Overview

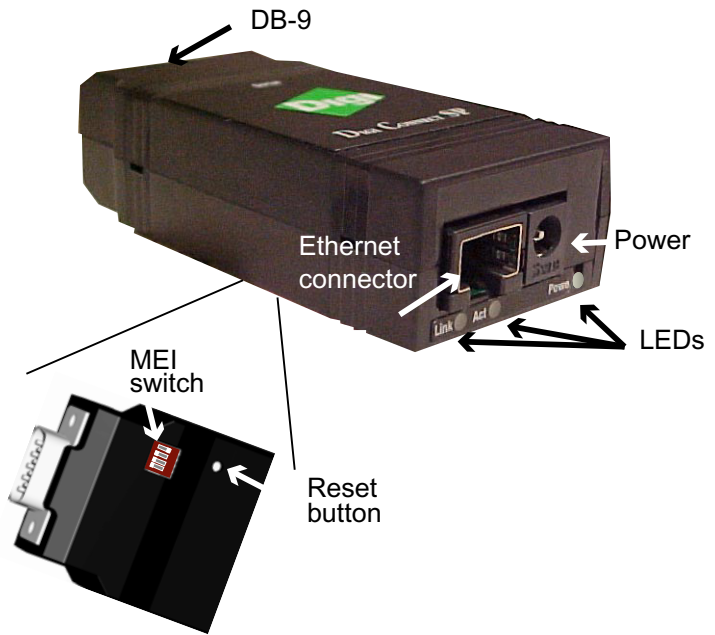

Note MEI switches and the Reset button are in the same location for both the Digi Connect SP and Digi Connect Wi-SP.

Digi Connect Wi-SP Overview



LEDs

The Digi Connect SP and Digi Connect Wi-SP provide three LEDs. Two of the LEDs are connected directly to the hardware; the other is software programmable. See the following table for more information.

LED Descriptions		
LED	Color	Purpose
Power	Red (labeled PWR)	This LED is software programmable. The default is that this LED indicates power (and is therefore always on). See “LEDs” on page 21 for more information

LED Descriptions		
LED	Color	Purpose
Link	Green	Network link status: <ul style="list-style-type: none"> – On - unit is associated with an access point – Blinking slowly - unit is in ad hoc mode – Blinking quickly - unit is scanning for a network
ACT	Yellow	This LED is wired to the Ethernet hardware. <ul style="list-style-type: none"> – On indicates bad initialization – Off indicates ready – Blinking indicates network activity

Reset Button

The behavior of the reset button is user-defined. See “Reset Button” on page 23 and the *NS520 BSP Porting Guide* for LED programming information.

Antenna

The Digi Connect Wi-SP is available with 1 RP-SMA connector. The antenna is connected to the product with a reverse polarity SMA connector (sub-miniature size A). The antenna only fits on the product one way to ensure a proper connection. Another option for both signal reception and design flexibility is to use a 30cm antenna extension cord (Digi part number DC-ANT-E-24DP) with .5dB loss to separate the antenna from the product..



Caution: This Part 15 radio device operates on a non-interference basis with other devices operating at this frequency when using the antennae listed in the Antenna Specification table. Any changes or modification to the product not expressly approved by Digi International could void the user's authority to operate the device.

Antenna Description			
Type	Desktop	Dipole	30 cm Antenna Extension Cord
Part number	DC-ANT-24DT	DC-ANT-24DP	DC-ANT-E-24DP
Gain	1.8 dBi	2 dBi	-.5dB

MEI 232/422/485 Switch Settings

These switches set the MEI (multiple electrical interface) line protocol on the serial interface.

Function	Switch Setting			
	1	2	3	4
EIA-232	Up	Down	Down	Down
EIA-422/485 full-duplex	Down	Up	Down	<ul style="list-style-type: none"> - If up, termination. - If down, no termination
EIA-485 half-duplex	Down	Down	Up	

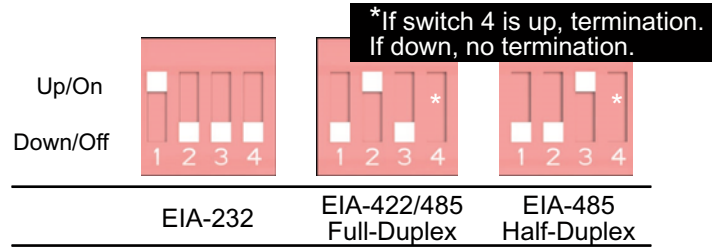

DB-9 Connector

The figure and table provide information on DB-9 pin orientation and pin assignments.

DB-9 Pin Orientation

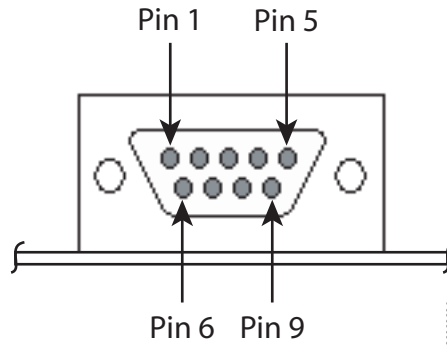

DB-9 Pin Assignments			
Pin	EIA-232	EIA-422/485 Full-Duplex	EIA-485 Half-Duplex
1	DCD	CTS-	Not used
2	RXD	RXD+	RXD+
3	TXD	TXD+	TXD+
4	DTR	RTS-	Not used
5	GND	GND	GND
6	DSR	RXD-	RXD-
7	RTS	RTS+	Not used
8	CTS	CTS+	Not used
9	NA	TXD-	TXD-

JTAG Interface

The Digi Connect SP Development Kit is provided with the case opened, providing access to the JTAG interface which mates with a JTAG debugger plug (for example, the Macraigor Raven included in the kit). See the following table for pin assignments on the JTAG adapter block provided.

JTAG Debugger Connector Pin Assignments													
Pin 1	Pin 2	Pin 3	Pin 4	Pin 5	Pin 6	Pin 7	Pin 8	Pin 9	Pin 10	Pin 11	Pin 12	Pin 13	Pin 14
VCC+	GND	/TRST	GND	TDI	GND	TMS	GND	TCK	GND	TDO	/SRST	VCC+	GND

Digi Connect SP JTAG Debugger Connector



Power Jack

The Power Jack is a barrel connector that accepts 9 to 30 VDC +/- 5%. The jack is labeled as P11 on the development board. The following table shows the polarity of the power jack.

Power Jack Polarity	
Contact	Polarity
Center	+9 to +30 VDC
Outer	Ground

The following figure schematically represents the polarity of the power jack.

Power Jack Polarity, Schematic

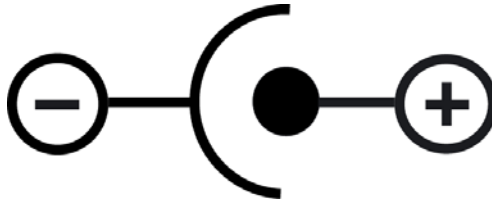

Programming Considerations

C H A P T E R 6

This chapter discusses programming consideration for the Digi Connect SP and Digi Connect Wi-SP and the NS7520 processor it is based on.

GPIO

General Information

The NS7520 processor supports 16 general purpose I/O (GPIO) pins, some of which are reserved for specific functions and some of which can be customized. These pins fall into three categories:

- Those labeled “Reserved” in the following table are dedicated to a specific use and must not be reprogrammed, or the unit may not operate correctly. Often, these pins are not connected to external interfaces.
- Those labeled “Allocated” in the following table are exposed to an external interface and allocated to a specific use by the software but can be customized safely with code modifications.
- Those labeled “Available” are exposed to an external interface, not controlled directly by the software, and can be customized.

GPIO Registers

Two registers, named PORTA and PORTC, govern the 16 GPIO pins. Each register is responsible for eight pins, and each GPIO pin uses the following four bits to completely describe its behavior:

- Mode (CMODE)
- Direction (CDIR)
- Special function (CSF). This is only applicable to PORTC.
- Data value

The first three bits describe the functionality of the GPIO pin. The data bit provides the current value of the pin when read and allows control of the value of an output pin when written.

In order to configure a pin as either a GPIO input or GPIO output, the corresponding bit positions in the appropriate register must be configured according to the information in the following table:

GPIO Configuration	
Input	Output
– CMODE = 0	– CMODE = 0
– CDIR = 0	– CDIR = 1
– CSF = 0	– CSF = 0

Since each register controls 8 GPIO pins, it is safest to read the full 32 bit register, modify the bits corresponding to the pin, and then write the full 32 bits back. In this way, the behavior of other GPIO pins will be preserved.

For more information regarding the format and programming of the GPIO registers, see the *NS7520 Hardware Reference*.

GPIO Pin Use

GPIO Pin Use			
Register Bit	Category	External Interface	Description
PORTA7 - PORTA0	Reserved	NA	NA
PORTC7	Reserved	NA	NA
PORTC6	Allocated	Connected to the red LED	Used as a power indicator (always on). It could be reassigned as a general purpose LED. It must remain a GPIO output for the LED to operate correctly. The LED is lit when the signal is a logic "high."
PORTC5	Available	Connected to the reset button.	It should be configured as a GPIO input.
PORTC4 - PORTC0	Reserved	NA	NA

LEDs

General information

The device server has two types of LEDs:

- LEDs connected directly to GPIO pins on the processor and controlled directly in software
- LEDs connected to other hardware components (normally the Ethernet hardware) and not directly programmable by the operating system

The development kit supplies software to control the LEDs. This behavior can often be modified by manipulating the LED table in the BSP code. See `gpio.c` for details.

As with any GPIO output, the GPIO register must be properly configured in order to assert values on the pin. The appropriate bits should be configured as:

- `CMODE = 0`
- `CDIR = 1`

- CSF=0

About LEDs

The device server has three LEDs:

- The green LED is wired directly to the Ethernet hardware and indicates that a link has been established.
- The yellow LED is wired directly to the Ethernet hardware and signals Ethernet activity.
- The red LED is software programmable. It is wired to processor GPIO register bit PORTC6. The LED is wired to be active high. The development kit software is implemented by default so that this LED reflects "power" (and is, therefore, always lit).

Flash

General Information

Digi Connect SP and Digi Connect Wi-SP device servers each have 4 MB of flash memory, which is controlled by chip select 0, located at 0x02000000.

Memory

Digi Connect SP and Digi Connect Wi-SP device servers each have 16 MB of SDRAM memory, which is controlled by chip select 1, located at 0x00000000 in the processor address space and aliased at 0x04000000 and 0x08000000. The application program (EOS) is loaded at address 0x08080000.

Reset Button

The device servers have a push button connected to a GPIO pin. This pin is named "/INIT." In the processor, the GPIO register bit associated with "/INIT" is PORTC5. The GPIO pin will read as high normally, and low when the button is pushed. See "Reset Button" on page 12 for the external location.

Reset Button



Specifications

A P P E N D I X A

Network Interfaces

Digi Connect SP

- RJ-45 connector
- 10/100Base-T
- Half- and full-duplex support

Digi Connect Wi-SP

- Standard: IEEE 802.11b
- Data Rate: Up to 11 Mbps with automatic fallback
- WEP (64-bit and 128-bit encryption)
- WPA (Wi-Fi Protected Access)/WPA2/802.11i
- Frequency: 2.4 GHz
- Modulation: CCK (11/5 Mbps), DQPSK (2 Mbps), DBPSK (1 Mbps)
- Transmit power: 16 dBm typical
- Receive sensitivity:
 - 1Mbps: -92 dBm
 - 2Mbps: -89 dBm
 - 5.5Mbps: -87 dBm
 - 11Mbps: -82 dBm
- Antenna connector: RP-SMA

- 10/100Base-T auto-sensing
- Half- and full-duplex support

Serial Interface

One EIA-232/422/485 switch-selectable serial port with full modem control.

Data Rates (bps)

50, 110, 134, 150, 200, 300, 600, 1200, 2400, 3600, 4800, 9600, 19200, 38400, 57600, 115200, 230400

Flow Control Options

RTS/CTS, XON/XOFF, None

Environmental

	Digi Connect SP	Digi Connect Wi-SP
Ambient Temperature	-40°F to 185°F (-40°C to 85°C)	-4°F to 185°F (-20°C to 85°C)
Storage Temperature	-40°F to 257°F (-40°C to 125°C)	
Humidity	5% to 90%	
Altitude	12000 feet (3657.60 meters)	

Power Requirements

Note: The Digi Connect SP and Digi Connect Wi-SP must be powered by a Listed LPS or Class II power supply rated 9-30 VDC, 0.37 A minimum.

Mechanical

Digi Connect SP

- Length: 3.876 inches (9.846 cm)
- Width: 1.680 inches (4.267 cm)
- Height: 0.999 inches (2.537 cm)
- Unit Weight: 2.29 oz (64.92 g)

Digi Connect Wi-SP

- Length: 3.876 inches (9.846 cm)
- Width: 1.680 inches (4.267 cm)
- Height: 0.999 inches (2.537 cm)
- Unit Weight: 1.968 oz (55.792 g)
- Antenna: .408 oz (11.567 g)
- Total Unit with Antenna: 2.376 oz (67.359 g)

Antenna Information

Antenna Strength

The following diagram demonstrates the strength of the signal received by the antenna on both a horizontal and vertical plane. The diagram shows the magnetic field when the antenna is in a vertical position. The red line represents the horizontal plane and the dotted green line represents the vertical plane. You can see in the illustration that at 90degrees, the signal strength is (as expected) 0.

Radiation Patterns

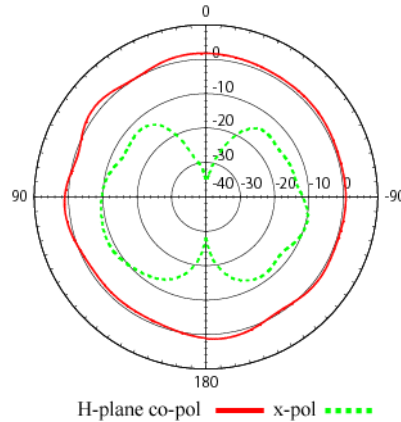

Antenna Details

Antenna Description	Dipole	Desktop
Part Number	DC-ANT-24DP	DC-ANT-24DT
Frequency	2.4~2.5 GHz	2.4~2.5 GHz
Power Output	2 W	1 W
DB Gain	2 dBi	1.8 dBi

Antenna Description	Dipole	Desktop
VSWR	< or = 2.0	1.92 max
Dimension	10.0x108.5 mm	105 x4.5 mm
Weight	10.5g	11 g
Connector	RP-SMA	RP-SMA

Antenna Restriction in North America

Only antennae of the same type listed on the FCC grant, with equal or lower antenna gain, may be used with the Digi Connect Wi-SP.

Desktop Antenna Dimensions

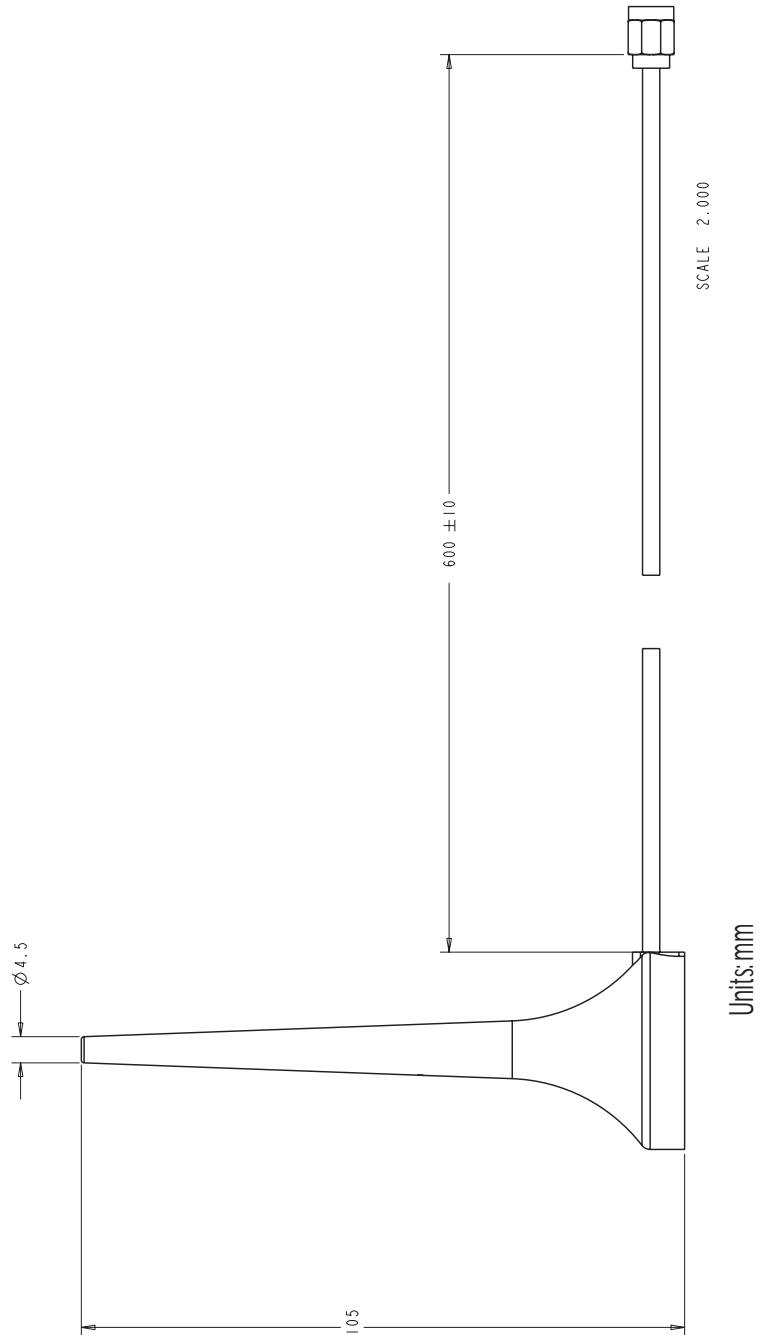

Dipole Antenna Dimensions

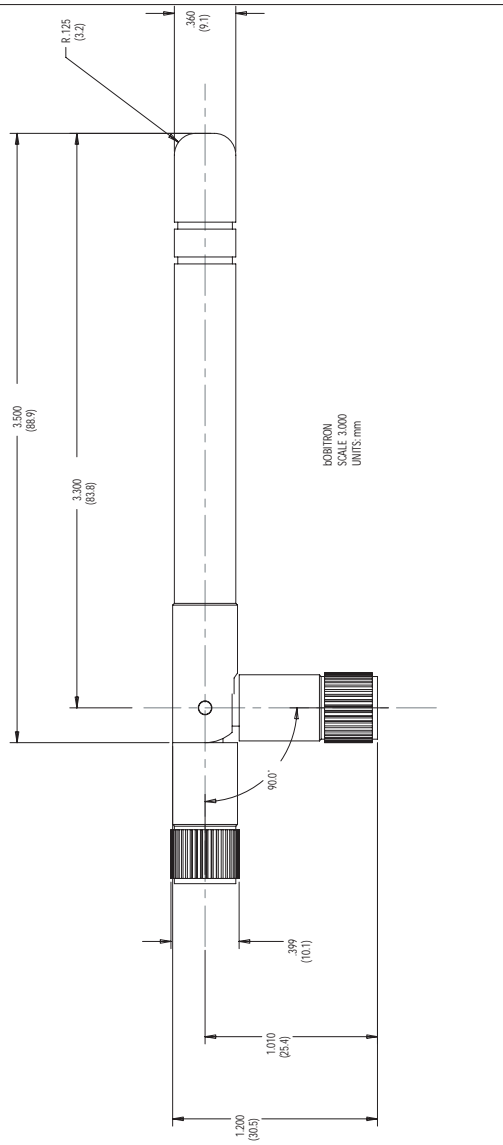

RF Exposure Statement

The Digi Connect Wi-SP device complies with the RF exposure limits for humans as called out in RSS-102. It is exempt from RF evaluation based on its operating frequency of 2400 MHz, and effective radiated power of less than (<) 400 milliwatts. This would be less than the 3 watt requirement for a mobile device (>20 cm separation) operating at 2400 MHz.

In order to comply with FCC RF exposure limits, dipole antenna should be located at a minimum distance of 7.9 inches (20 cm) or more from the body of all persons.

Overlay Specifications

The following specifications are for the product overlays.

Digi Connect Wi-SP

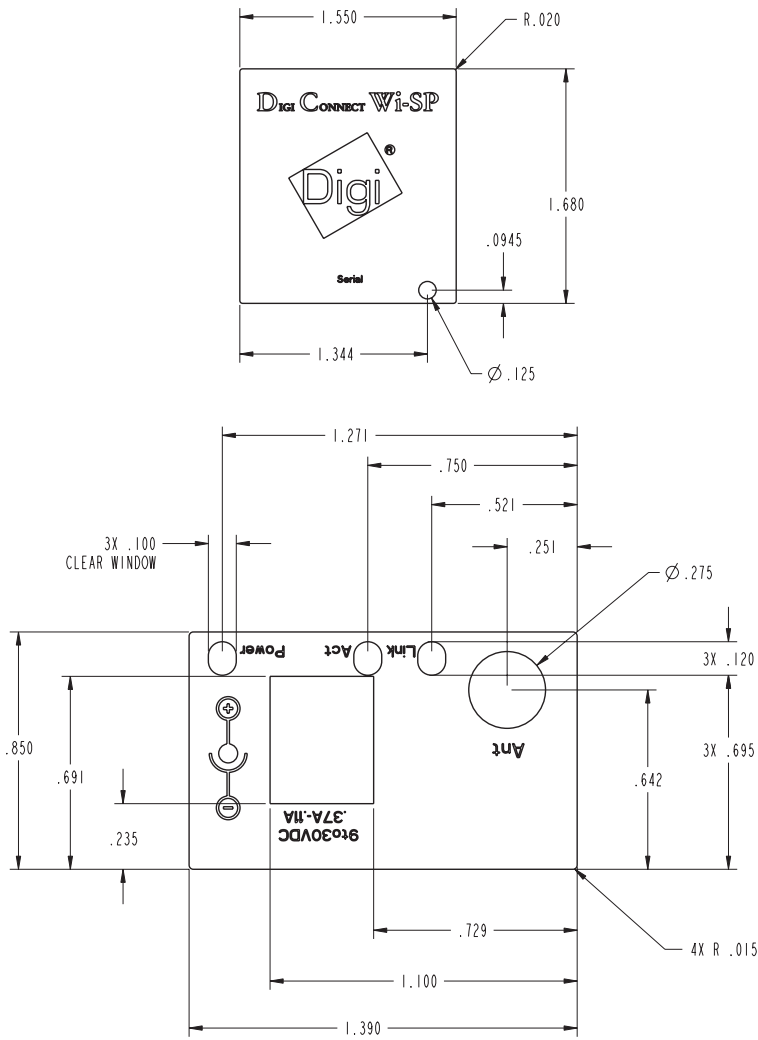

Unit: inches

Digi Connect SP

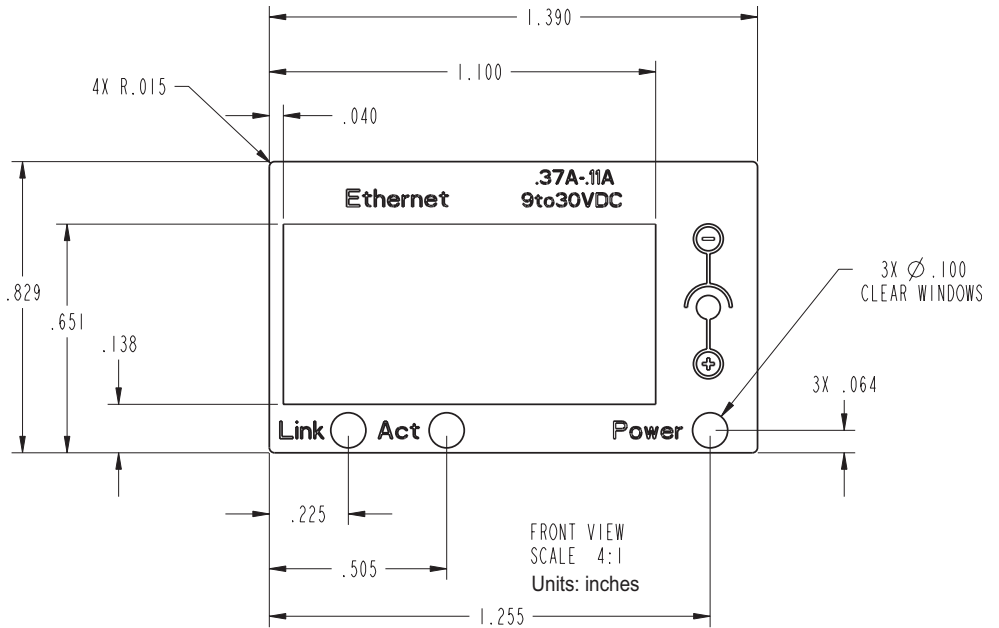
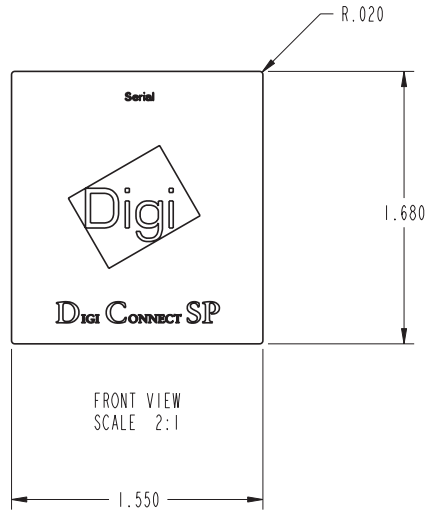

Certifications

A P P E N D I X B

These products comply with the following standards.

FCC Part 15 Class A

Radio Frequency Interference (RFI) (FCC 15.105(a))

The Digi Connect SP and Digi Connect Wi-SP have been tested and found to comply with the limits for Class A digital devices pursuant to Part 15 of the FCC Rules. These limits are designed to provide reasonable protection against harmful interference when the equipment is operated in a commercial environment. This equipment generates, uses, and can radiate radio frequency energy, and if not installed and used in accordance with the instruction manual, may cause harmful interference to radio communications. Operation of this equipment in a residential area is likely to cause harmful interference in which the user will be required to correct the interference at his own expense.

Labeling Requirements (FCC 15.19)

This device complies with Part 15 of FCC rules. Operation is subject to the following two conditions: (1) this device may not cause harmful interference, and (2) this device must accept any interference received, including interference that may cause undesired operation.

Modifications (FCC 15.21)

Changes or modifications to this equipment not expressly approved by Digi may void the user's authority to operate this equipment.

Cables (FCC 15.27)

Shielded cables *must* be used to remain within the Class A limitations.

Industry Canada

This digital apparatus does not exceed the Class A limits for radio noise emissions from digital apparatus set out in the Radio Interference Regulations of the Canadian Department of Communications.

Le present appareil numerique n'emet pas de bruits radioelectriques depassant les limites applicables aux appareils numeriques de la class A prescrites dans le Reglement sur le brouillage radioelectrique edicte par le ministere des Communications du Canada.

International EMC Standards

The Digi Connect SP and Digi Connect Wi-SP meet the following standards.

Standards	Digi Connect SP	Digi Connect Wi-SP
Emissions	AS/NZS 3548	AS/NZS 3548 CISPR 22
		FCC Part 15 Subpart C (FCC ID: MCQ-50M1312)
		IC RSS 210 (IC:1846A-50M1312)
	ICES-003 EN 55022 EN 61000-3-2 EN 61000-3-3 EN 301 489- 3 EN 300 328 VCCI	
Immunity	EN 55024	
Safety	UL 60950-1 CSA 22.2 No. 60950--1 EN 60950	



Change Log

A P P E N D I X C

The following changes have been made since the last release of this document.

Revision D

- Updated Antenna drawing
- Changed antenna restriction in North America
- Added product weight

Revision C

- Changed RAM from 8 MB to 16 MB.
- Added overlay drawings.
- Added desktop antenna information.
- Added Japan certification.
- .



